

12 59 00  
SYSTEMS FURNITURE  
MODULES AND FINISH SELECTION GUIDE

# TABLE OF CONTENTS

## 12 50 00 B

### MODULES AND FINISH SELECTION GUIDE

#### 00

##### INTRODUCTION

#### 01

##### COMPONENTS

#### 02

##### BENCHING

- Open Plan
- Benching Office

#### 03

##### OPEN WORKSTATIONS

- Columbia Basic
- Columbia Basic Plus
- Columbia Enhanced
- Columbia Ergonomic
- Columbia Hoteling

#### 04

##### OFFICES

- Columbia Basic
- Columbia Enhanced
- Columbia Ergonomic

#### 05

##### EXECUTIVE OFFICES

- Columbia Enhanced
- Columbia Ergonomic

#### 06

##### FINISHES

# INTRODUCTION

What's In Store For The Next Decade of Office?

## RESIMERCIAL

It's not so much about where we work, but understanding how we work...

Workplaces are investments that affect a company's productivity, culture, and reputation.

An experiential workplace is a work environment designed to provide employees with meaningful and engaging experiences that go beyond the traditional work tasks and responsibilities.

The revised CU Furniture Modules and Finishes standards were developed with the following criteria:

### Space Efficiency

By introducing slimmer dividers (Answer Boundary Screen) and a narrower desk return, the workstation footprint increased in open area feeling less constricted.

Declutter. With the work becoming more digital we no longer require tons of filing space, capitalizing on leg room.

### Sustainability

Sustainability is taking a central role. With the climate crisis and ecological impact becoming part of mainstream discourse, many offices are taking nature into account as well. Recycling, use of environment-friendly materials, reduction of plastic, and energy saving are all becoming an integral part of office design.

We are contributing to less waste with purposeful and functional components.

### Modern Aesthetics

Warmer and welcoming finishes that evoke the feeling of comfort.

### Cost Conscious

Decreased cost for the basic option.

Wiser investment of an ergonomic option for the price of the previous standard module

# LAWS, CODES AND WARRANTIES

## Accessibility

Columbia University (CU) is committed to fostering a fully accessible campus. The **Americans with Disabilities Act (ADA)**, the **Americans with Disabilities Act Amendments Act (ADAAA)**, and Section 504 of the Rehabilitation Act of 1973, are both a law and a code that prohibit discrimination against persons with disabilities. A myriad of other federal and state laws pertaining to individuals with disabilities mandate a complex set of requirements.

Universal design and ADA compliance encompass many aspects of furniture such as clearance requirements (heights, depths, and widths), ease of approachability and maneuverability within the space, and the ease of manipulation of knobs, handles, or adjustments.

## Fire Life Safety

CU must also comply with current codes, rules and regulations of the City of New York regarding Fire and Life Safety. Important code provisions include, but are not limited to, maintaining an egress path and the height of furniture partitions to be 18" below the ceiling height.

In addition, CU has a policy that outlines the University's voluntary compliance with flammability standards. More detail can be found here:

[Fire Safety Requirements for Upholstered Furniture and Furnishings | University Policies \(columbia.edu\)](#)

*Note: Residential grade seating products do not conform to the CU policy above.*

**All purchased furniture and workspace layouts must meet ADA and Fire Life Safety requirements.**

CU has vendor agreements with Steelcase as a preferred manufacturer through Empire and Waldners. Under this agreement, warranties are covered for contract grade furniture. Products that qualify can be found in the [CU Furniture Look Book](#)

# LAWS, CODES AND WARRANTIES

## Warranties

CU has a vendor agreement with Steelcase as a preferred manufacturer, offering significant discounts on a broad selection of products. Steelcase furniture is purchased through one of two dealers - Empire or Waldners. Under this agreement, warranties cover contract grade furniture. Products that qualify can be found in the [CU Furniture Look Book](#).

CUFO has assembled the following products and workspace layouts that incorporate all laws, codes and best practices, along with comparative pricing information to assist you with your initial research.

The Columbia University Design and Compliance team (DAC) is available to assist with accessibility and code specific inquiries. If any questions, please reach out to Design and Compliance at [cufdr-feedback@columbia.edu](mailto:cufdr-feedback@columbia.edu).

# FEATURING

## NEW PRODUCTS

- Gallery panel : **Answer Boundary** screen
- Ledge: **Personal Shelf**

## STANDARD PRODUCTS

- Open Benching : **Frame One**
- 'Spine' **Answer Panel**
- Adjustable desk : **Migration** (expect for 90-degree desk)
- Task Chairs :
  - Student : **Series 1**
  - Offices: **Amia** or **Think**
  - Guest: **Enea Lotus** or **QiVi**

## OVERALL DIMENSIONS

- Student Bench : 24" width typical X 48" length
- Office Bench : 24" width typical X 5'-6" length
- Workstation : 24" width main and 18" width return
- Offices: 24" width main and return

## LEGEND:

-  Economical
-  Mid-range
-  Premium

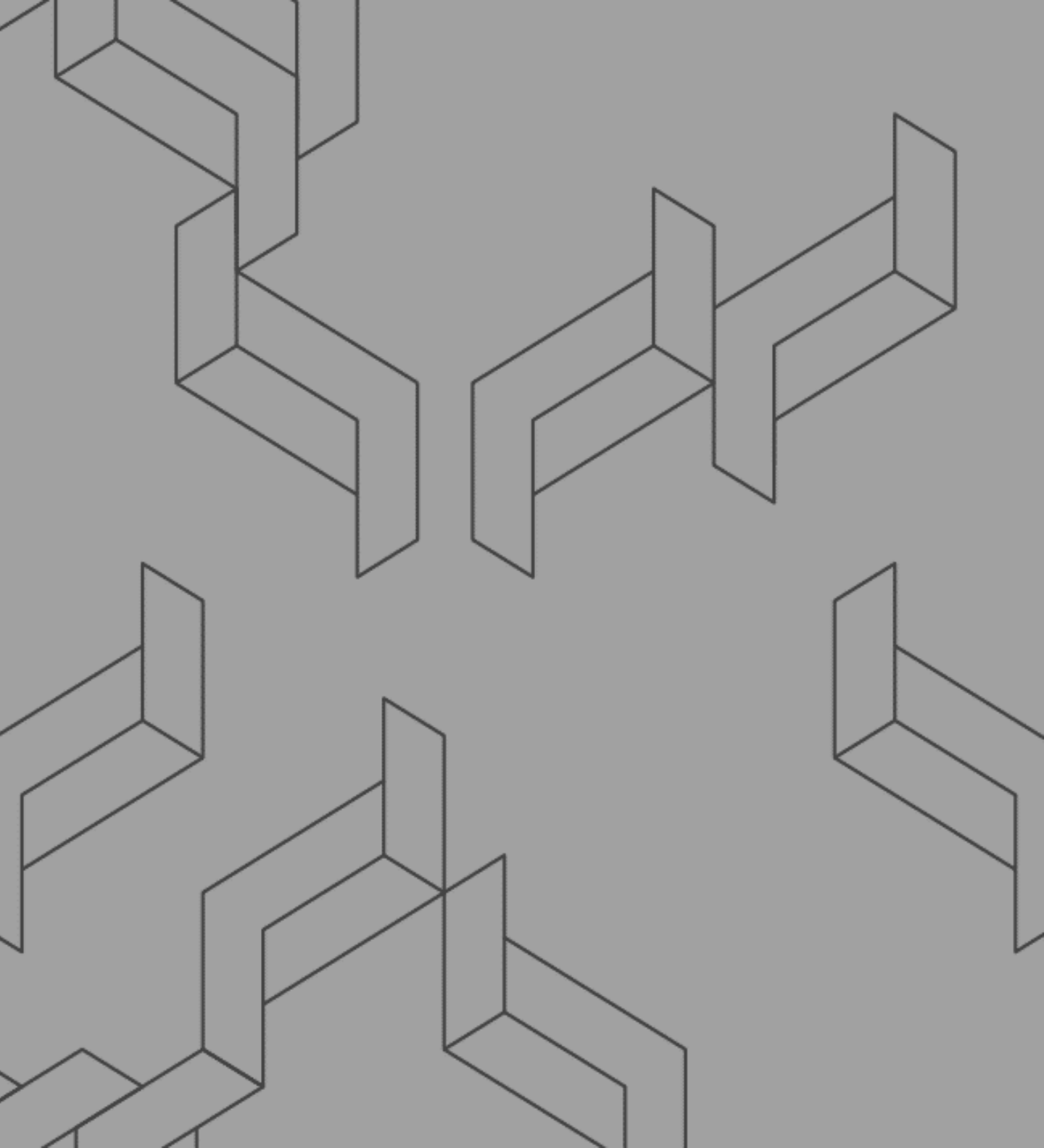

01  
DESKS COMPONENTS

# DESK COMPONENTS

## WORK SURFACES



## LEG PROFILES

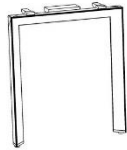
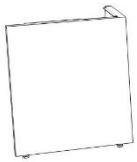

## ABOVE DESK STORAGE

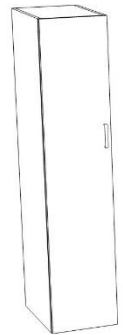
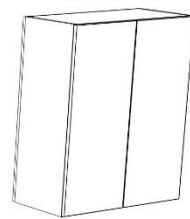
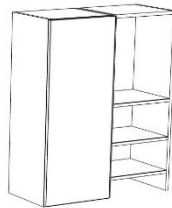

## BELOW DESK STORAGE





# ACCESORIES

## TACK BOARDS



## BOUNDARY SCREEN

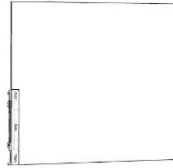

## CUBBIES

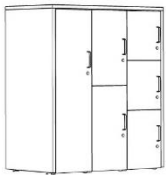

## POWER



## TASK & GUEST CHAIRS



## TABLES



-BLANK PAGE-



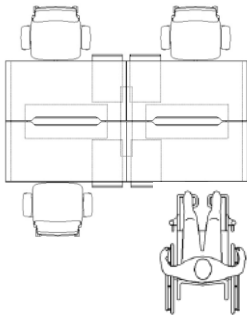

BENCHING

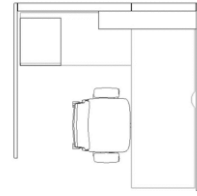

OPEN WORKSTATIONS

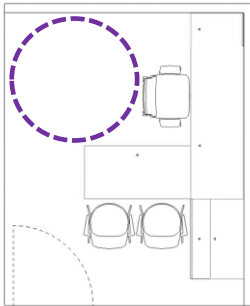

OFFICE

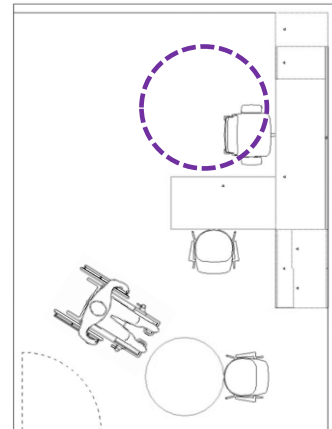

EXECUTIVE OFFICE



BENCHING OPEN PLAN  
Typical Module - 2'X 4'-0"  
Cost: \$5,462.38

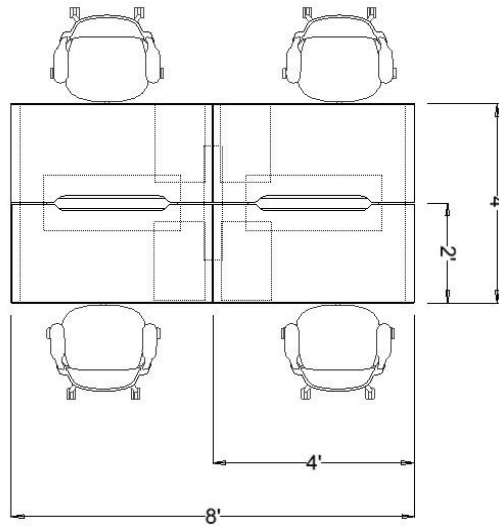

Dimensions

View

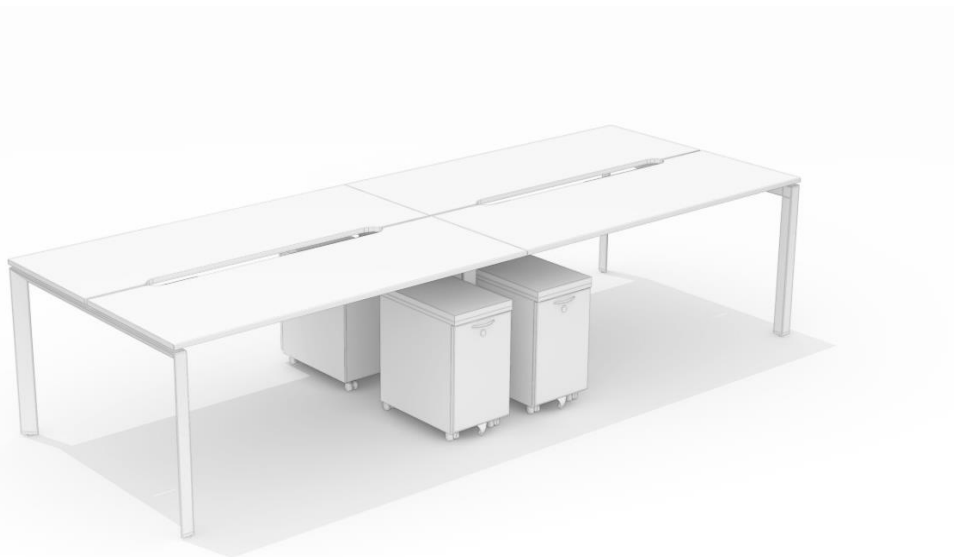

BENCHING w/ SCREENS  
Typical Module - 2' X 4'-0"  
Cost: \$8,077.37

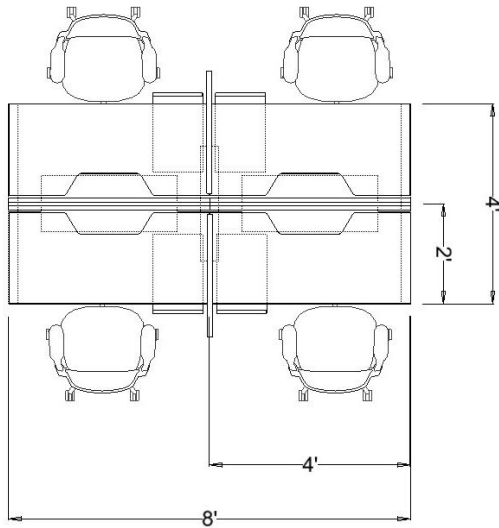

Dimensions

View

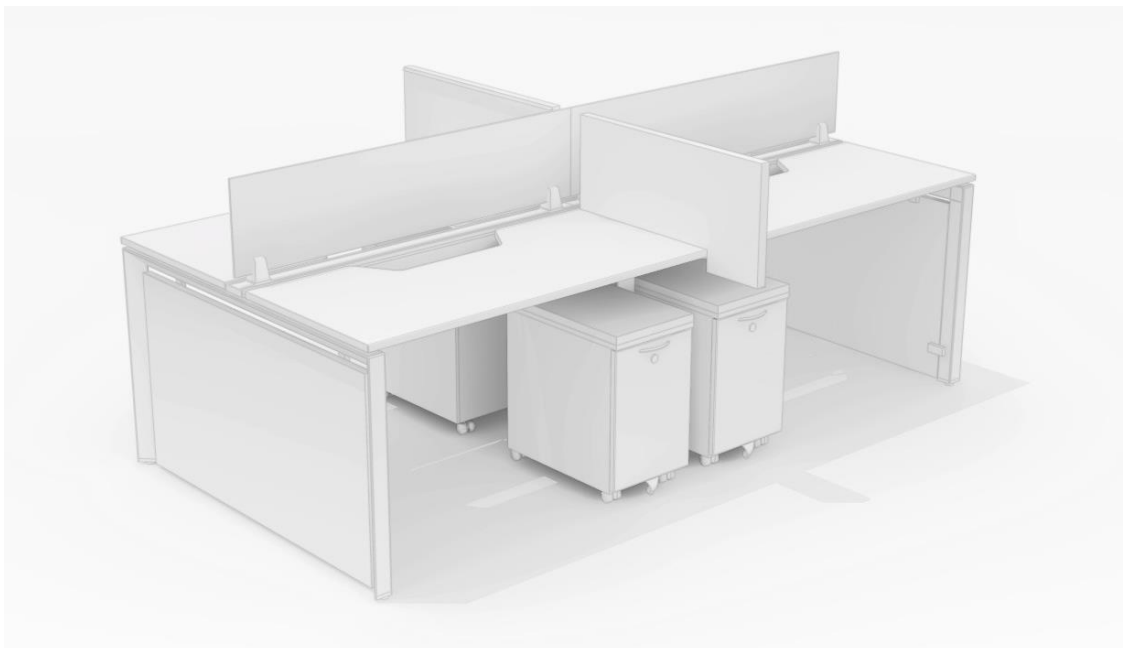

# BENCHING OFFICE SEATED

Typical Module - 2'X 5'-6"

Cost: \$6,742.19

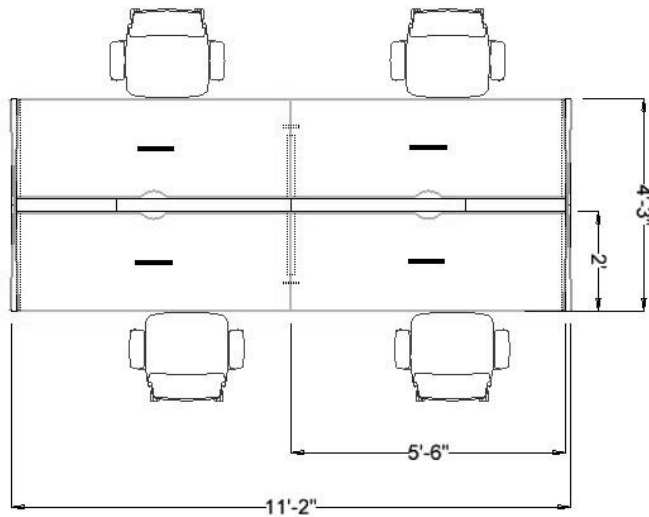

Dimensions

View

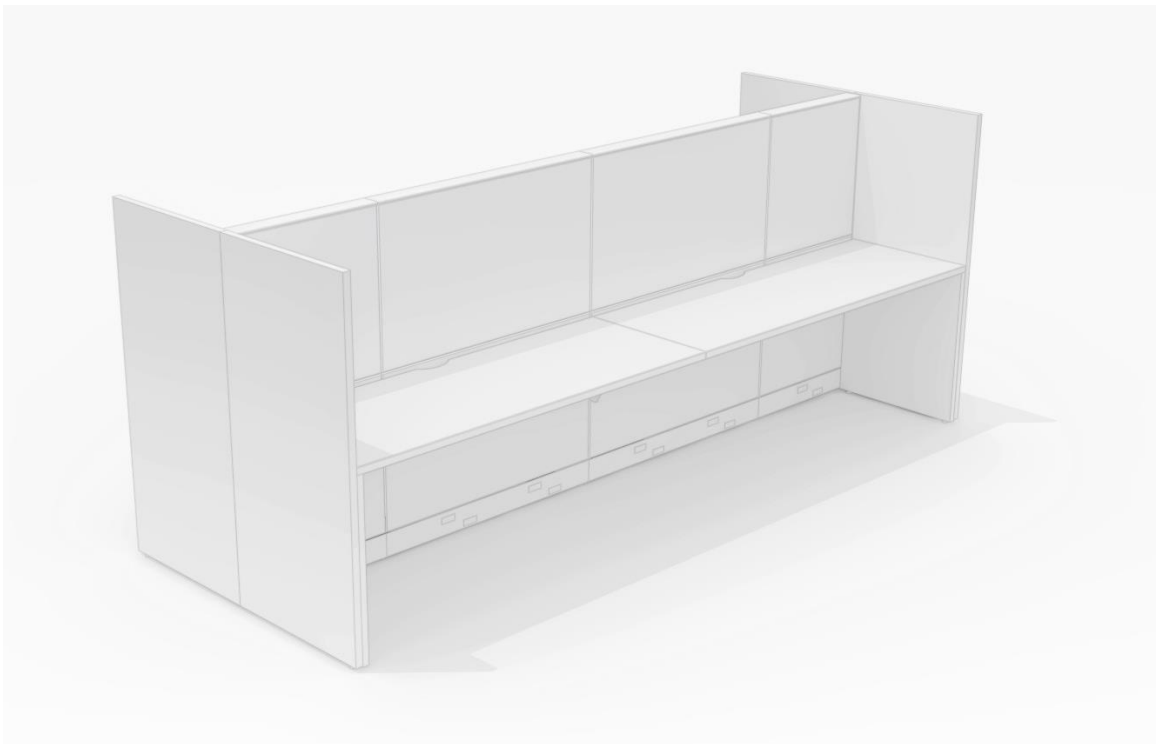

# BENCHING OFFICE STANDING

Typical Module - 2'X 5'-6"

Cost: \$8,241.82

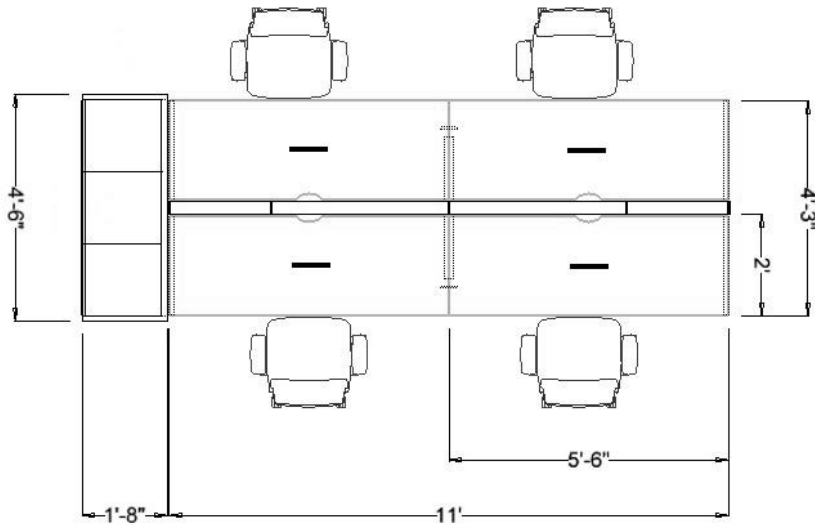

Dimensions

View

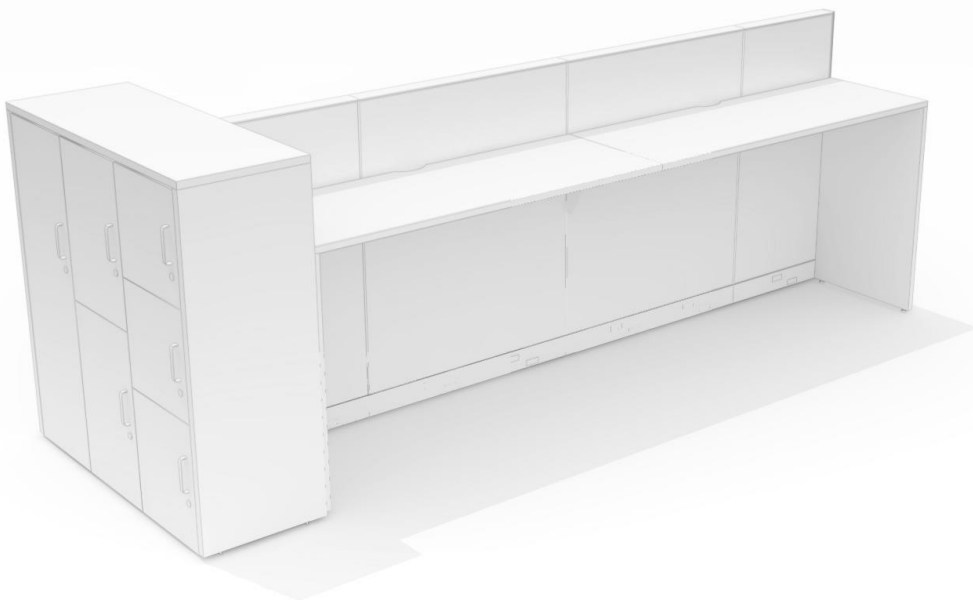

BENCHING  
Typical Modules  
Columbia Acacia



Office Seated  
Open Plan



Office Standing  
w/ Dividers











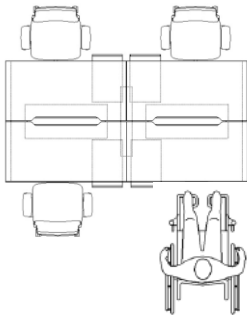

BENCHING

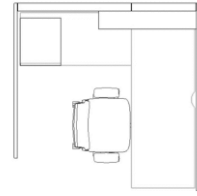

WORKSTATIONS

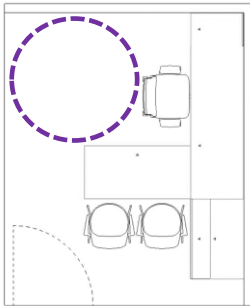

OFFICE

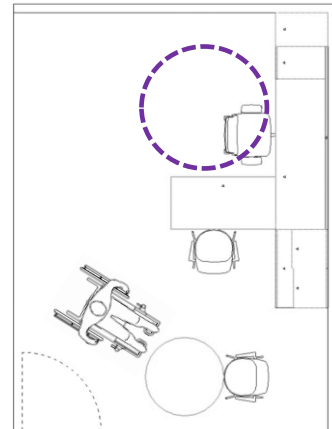

EXECUTIVE OFFICE



## OPEN WORKSTATIONS

Typical Module - 5'-6" x 5'-6"

Current Standard

Cost: \$18,372.96 total sell

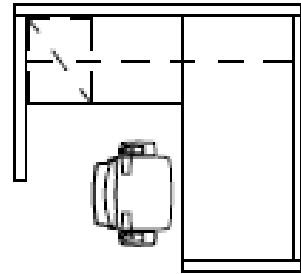

View 1

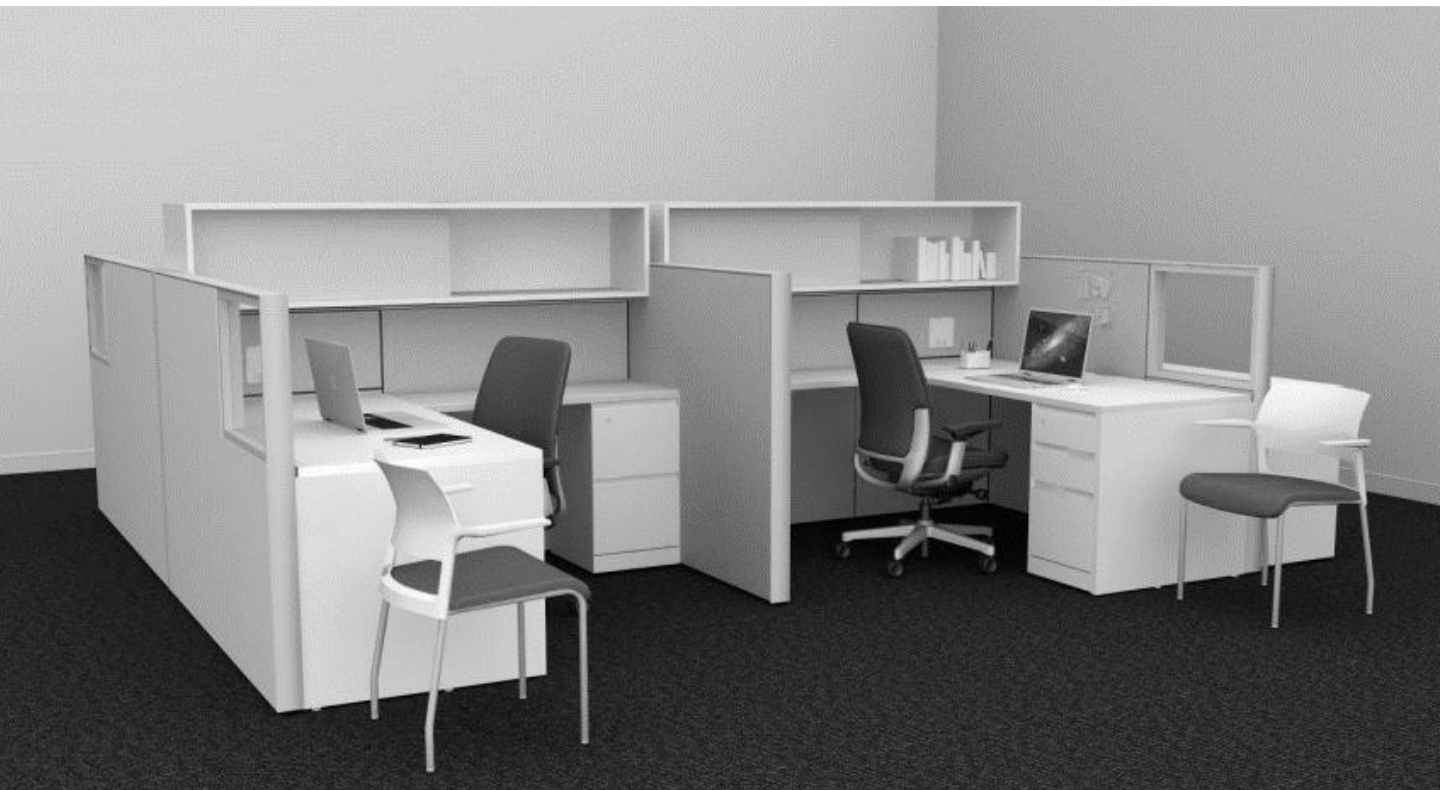



# OPEN WORKSTATIONS

Typical Module - 5'-6" x 5'-6"

Columbia Basic (metal leg & cabinet)

Cost: \$ [10,848.83 total sell]

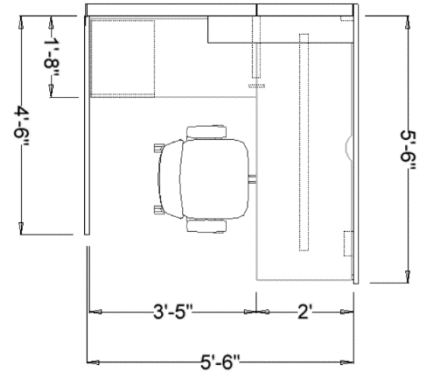
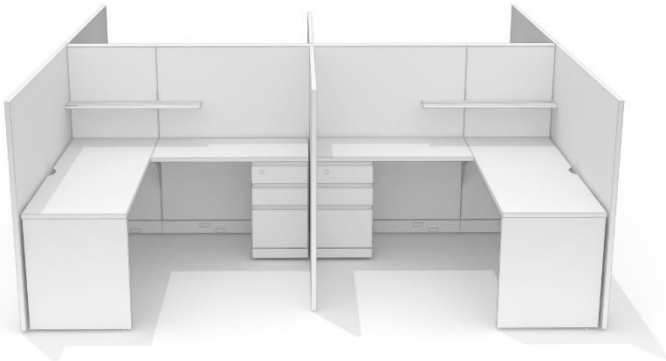

View 1

Dimensions

View 2

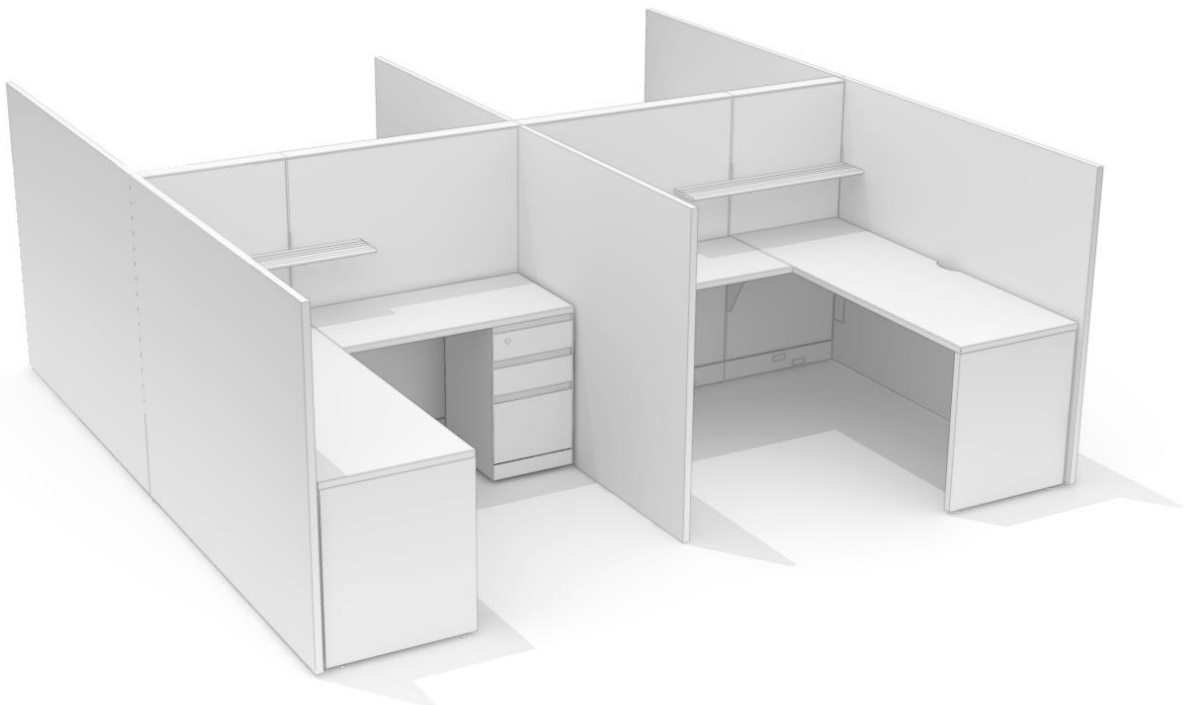

# OPEN WORKSTATIONS

Typical Module - 5'-6" x 5'-6"

Columbia Basic Plus (open metal leg & cabinet)

Cost: \$\$ [11,220.75 total sell]

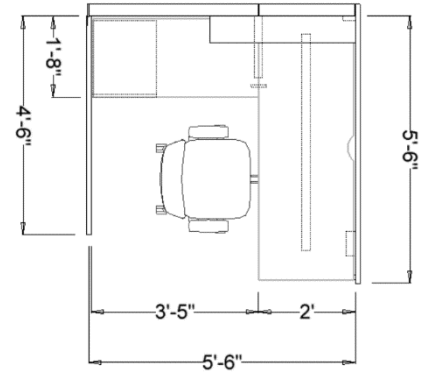
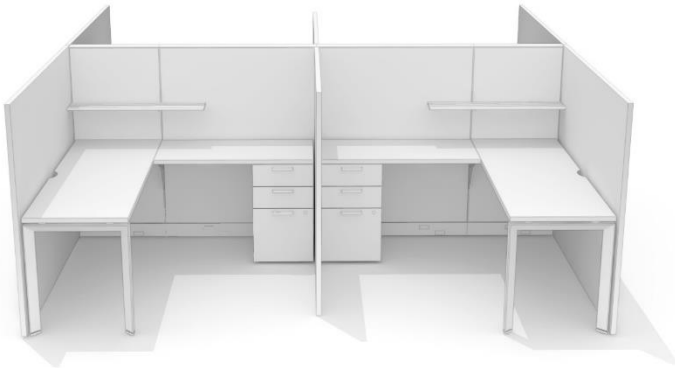

View 1

Dimensions

View 2

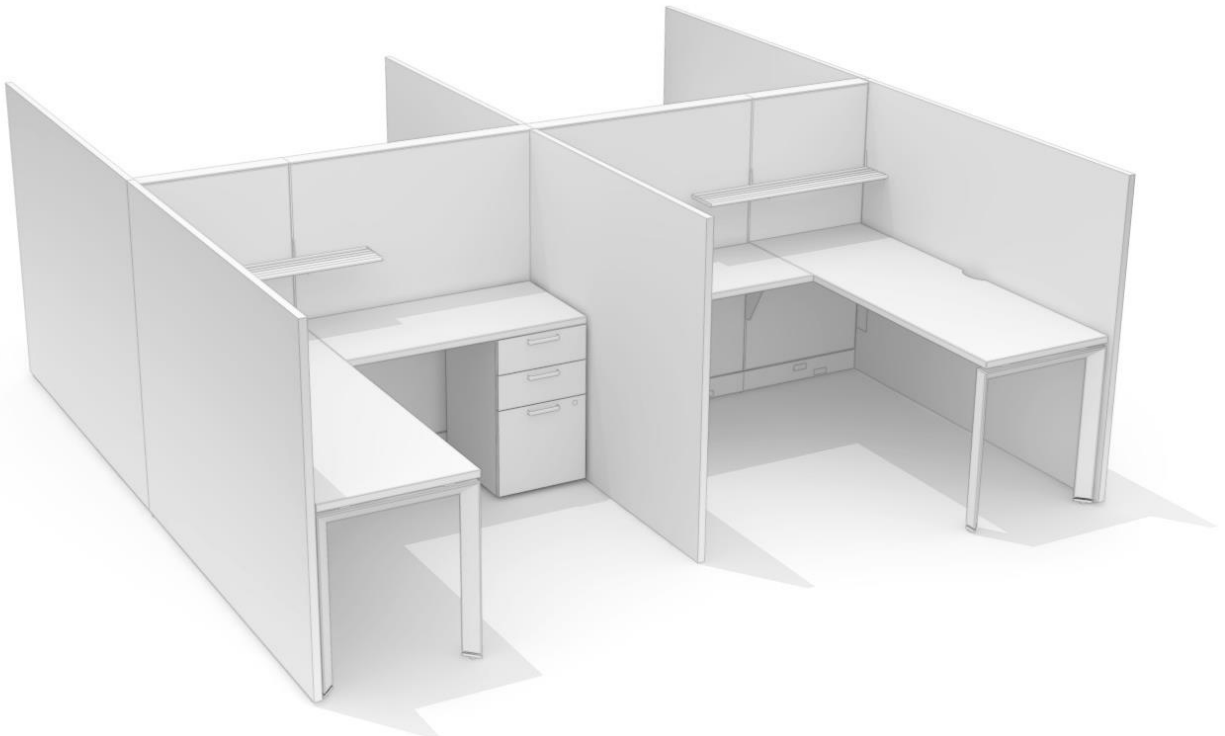

# OPEN WORKSTATIONS

Typical Module - 5'-6" x 5'-6"

Columbia Enhanced (laminated leg & cabinet)

Cost: \$\$ [11,523.75 total sell]

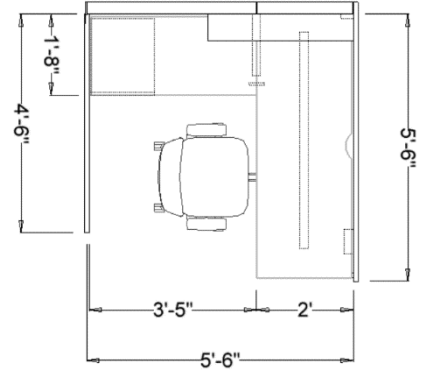
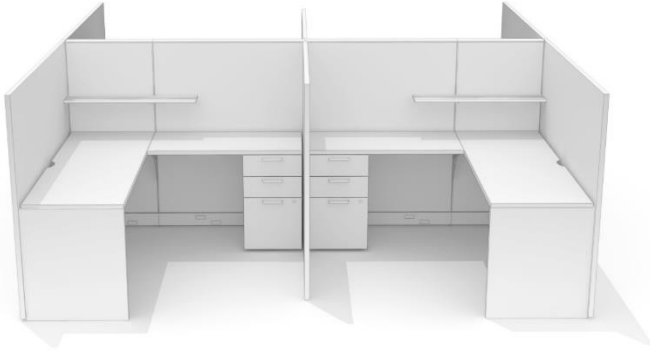

View 1

Dimensions

View 2

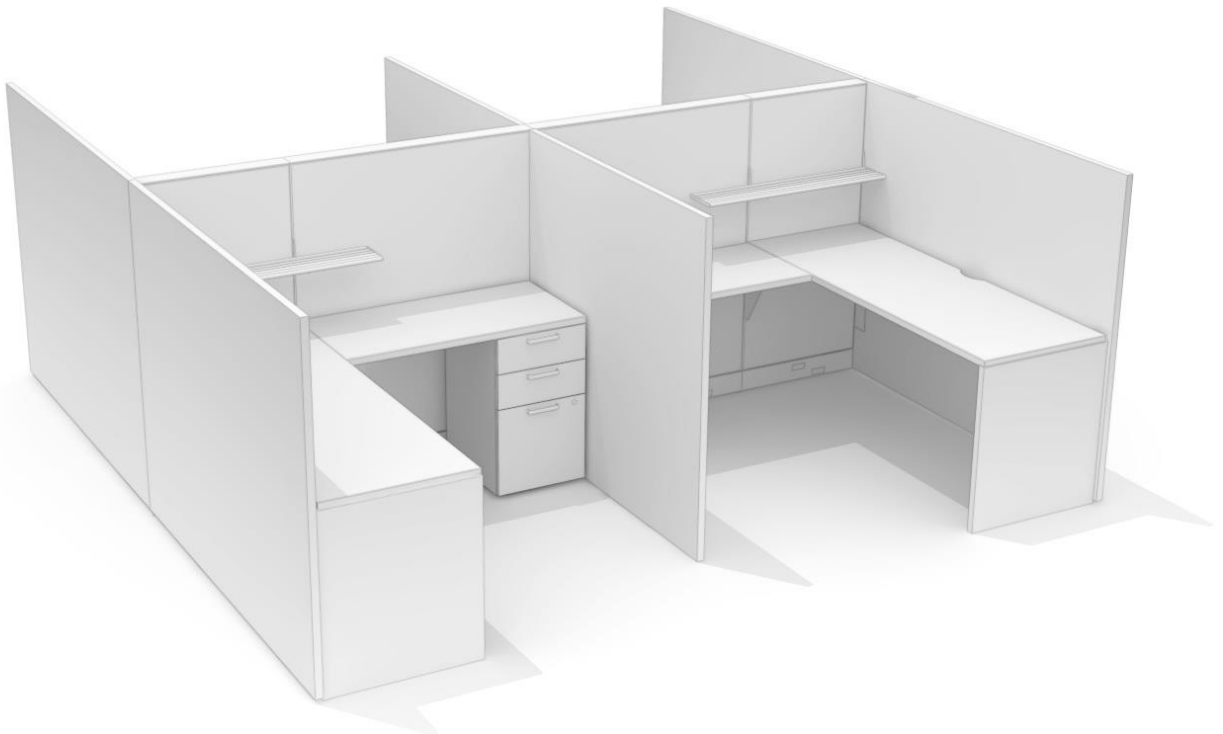

# OPEN WORKSTATIONS

Typical Module - 5'-6" x 5'-6"

Columbia Ergonomic

Cost: \$\$\$ [17,191.48 total sell]

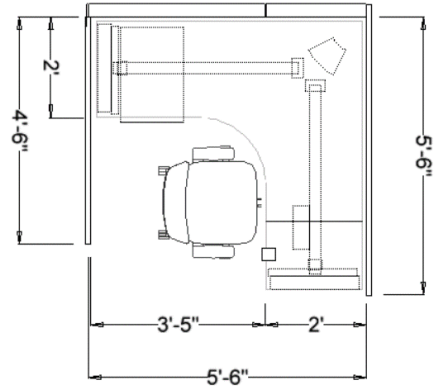
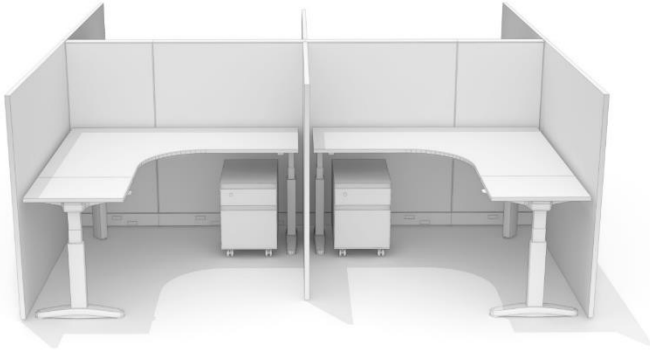

View 1

Dimensions

View 2

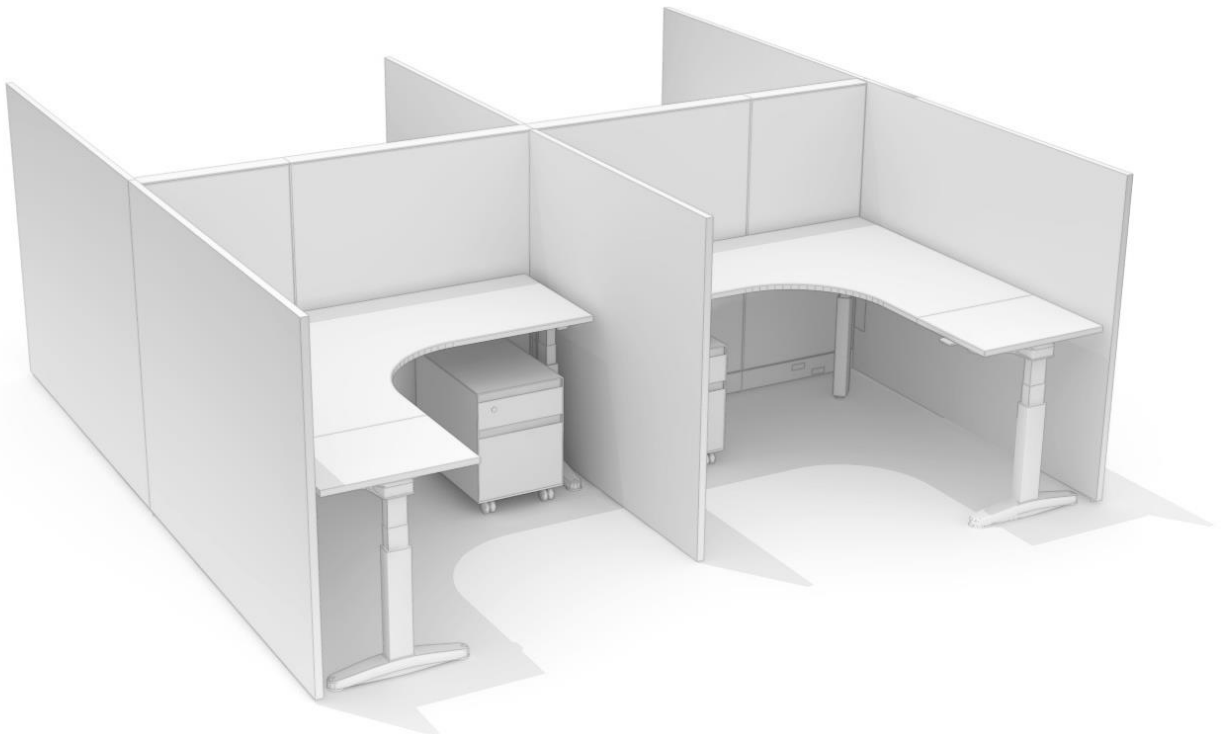



# OPEN WORKSTATIONS

Typical Module - 5'-6" x 5'-6"

Columbia Hoteling

Cost: \$\$\$ [13,259.24 total sell]

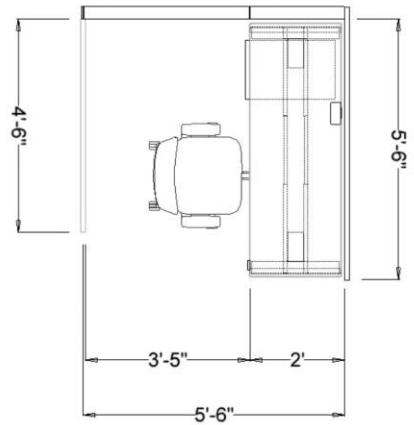
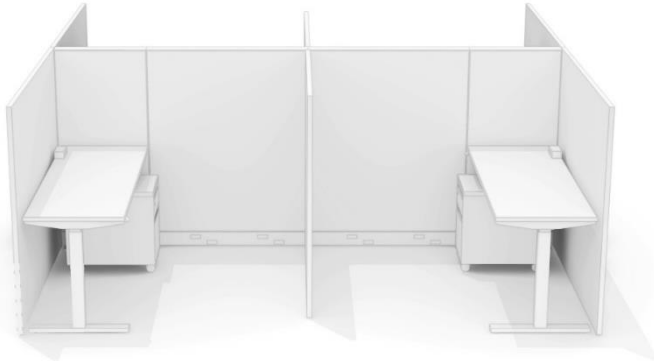

View 1

Dimensions

View 2

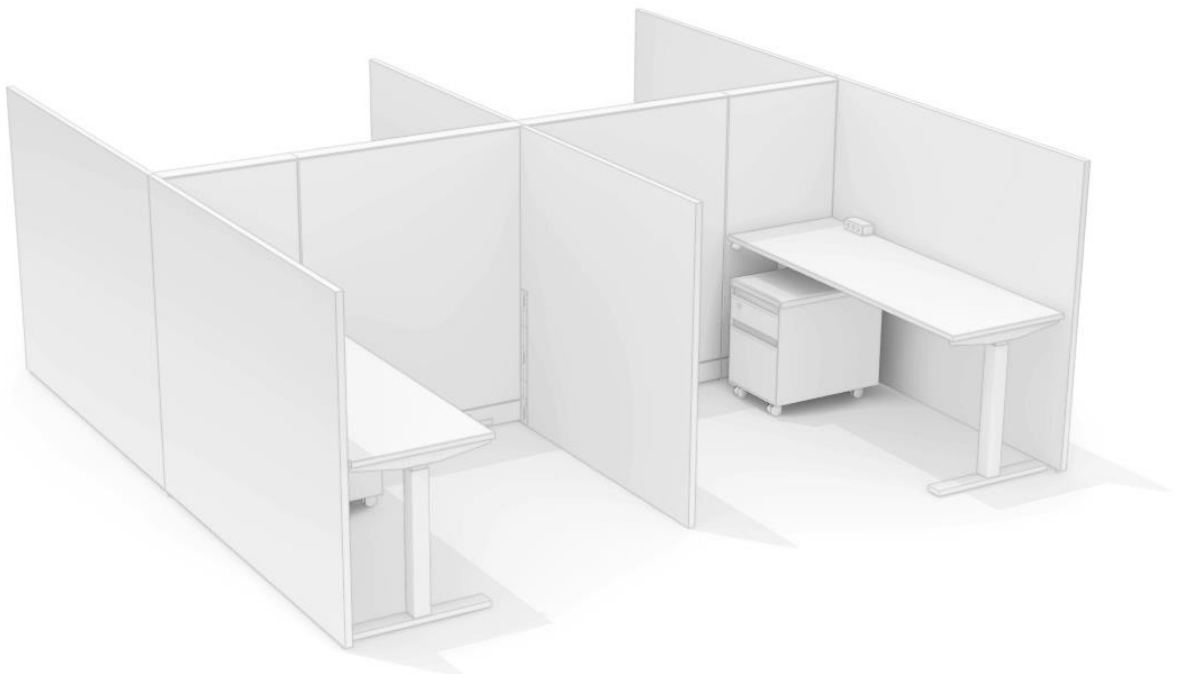

# OPEN WORKSTATIONS

Typical Module - 5'-6" x 5'-6"

Columbia Hoteling Plus

Cost: \$\$\$ [\$14,103.46 total sell]

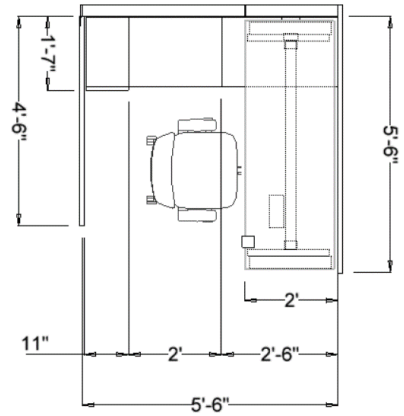

View 1

Dimensions

View 2

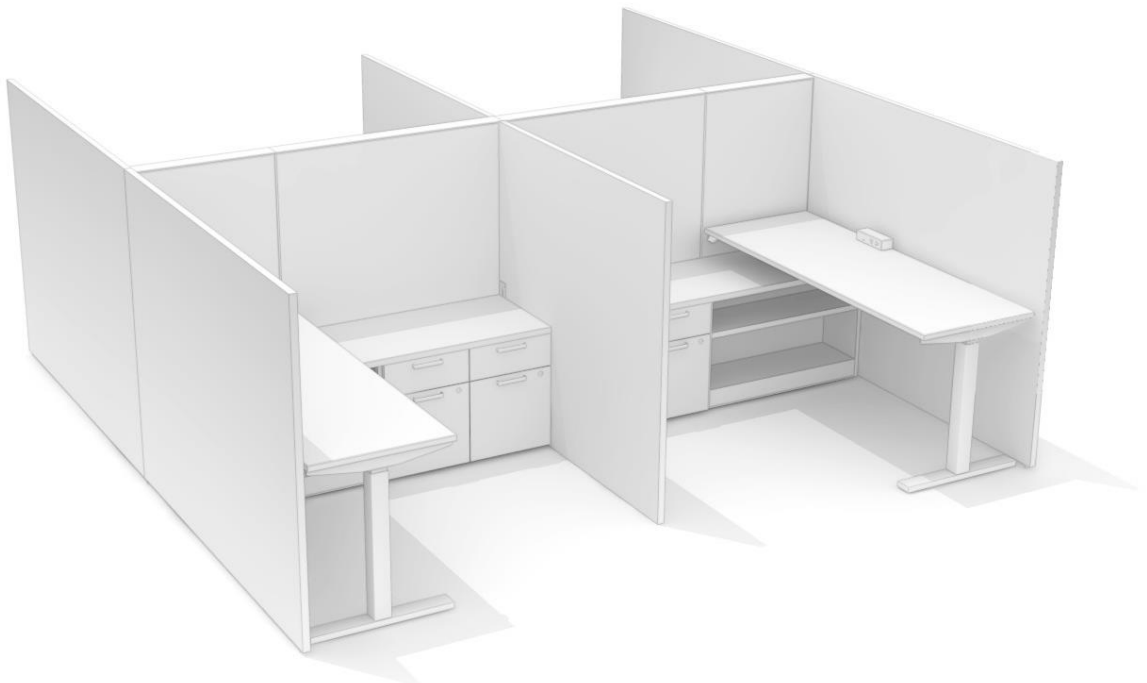

# OPEN WORKSTATIONS

Typical Module - 5'-6" x 5'-6"

Columbia Acacia

Cost: \$\$ [11,500.00 total sell estimate]

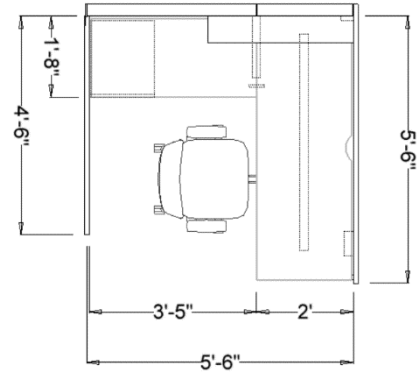

View 1  
Palette 1

Dimensions



# OPEN WORKSTATIONS

Typical Module - 5'-6" x 5'-6"

Columbia Walnut

Cost: \$\$ [11,500.00 total sell estimate]

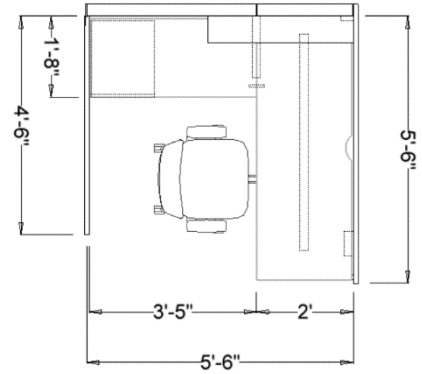

View 1

Dimensions

Palette 2



# OPEN WORKSTATIONS

Typical Module - 5'-6" x 5'-6"

Columbia Oak

Cost: \$\$ [11,500.00 total sell estimate]

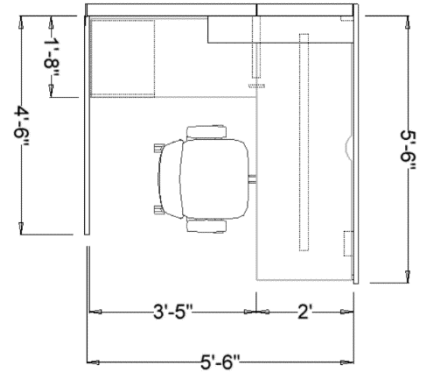

View 1

Dimensions

Palette 3















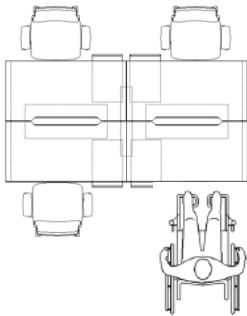

BENCHING

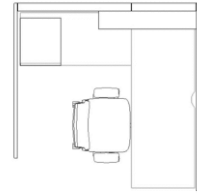

WORKSTATIONS

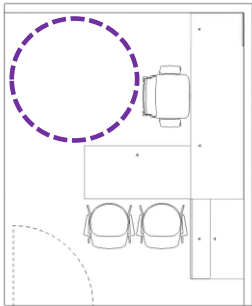

OFFICES

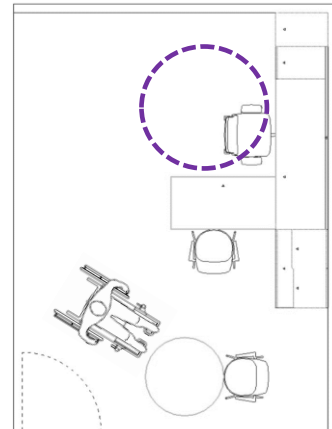

EXECUTIVE OFFICES



## SEMI- PRIVATE OFFICE

Typical Module - 5'-6" X 7'-6"

Columbia Basic (open metal leg, laminate cabinet, shelves)

Cost: \$\$\$ [24,937.97 total sell]

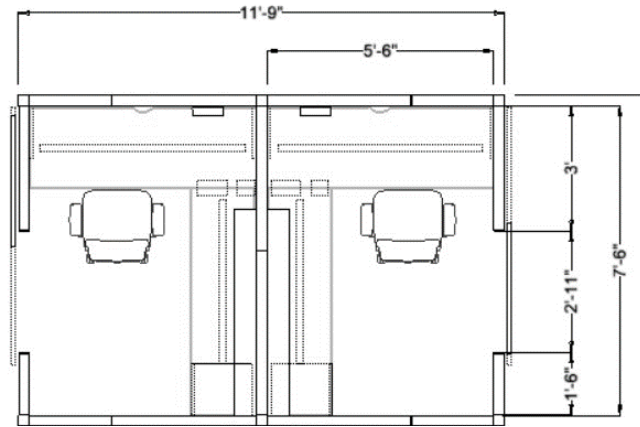

View 1

Dimensions

View 2



# MONTAGE OFFICE

Typical Module - 9'-0" X 11'-0"

Columbia Basic (open metal leg, laminate cabinet, shelves)

Cost: \$\$\$ [24,121.55 total sell]

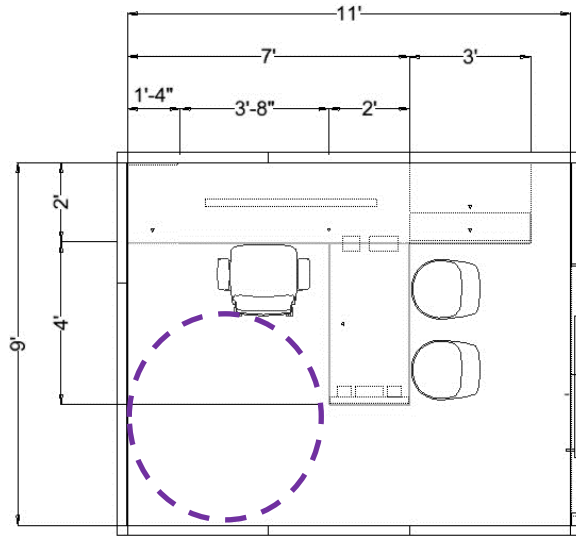

View 1

Dimensions

View 2



# OFFICE

Typical Module - 9'-0" X 11'-0"

Columbia Basic

Cost: \$ [7,437.44 total sell]

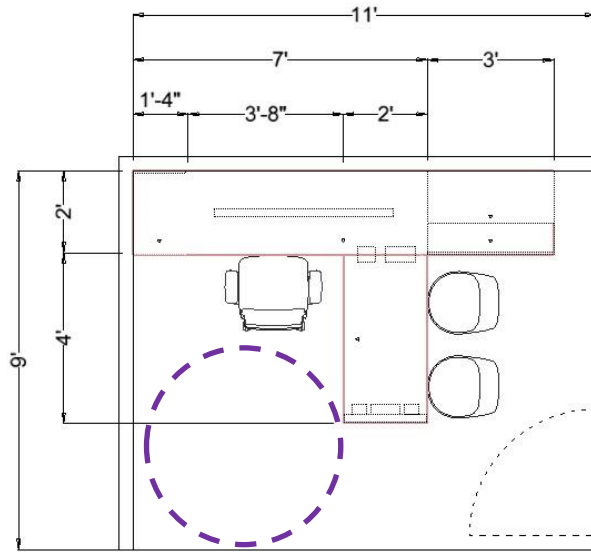

View 1

Dimensions

View 2



# OFFICE

Typical Module - 9'-0" X 11'-0"

Columbia Enhanced

Cost: \$\$ [8,761.61 total sell]

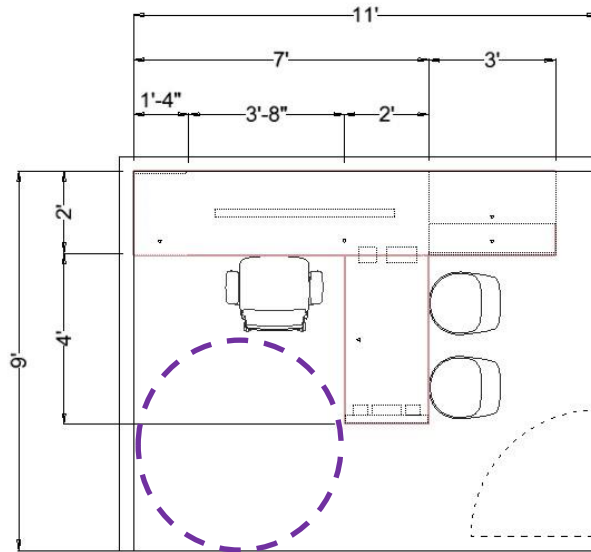

View 1

Dimensions

View 2



# OFFICE

Typical Module - 9'-0" X 11'-0"

Columbia Ergonomic

Cost: \$\$\$ [9,899.07 total sell]

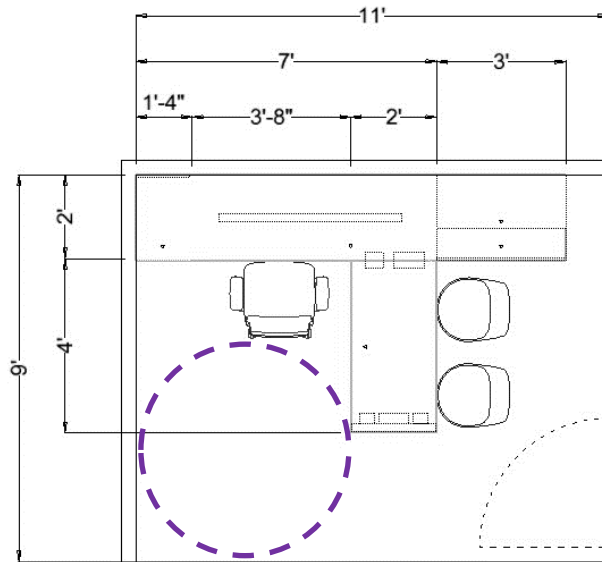

View 1

Dimensions

View 2



# OFFICES

Typical Modules 9'-0" X 11'-0"  
Columbia Oak



# OFFICES

Typical Modules 9'-0" X 11'-0"

Columbia Acacia





# OFFICES

Typical Modules 9'-0" X 11'-0"  
Columbia Walnut











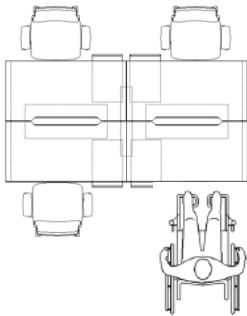

BENCHING

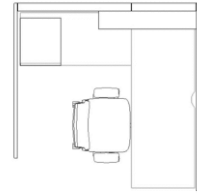

WORKSTATIONS

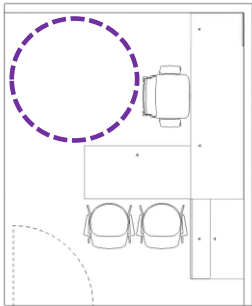

OFFICES

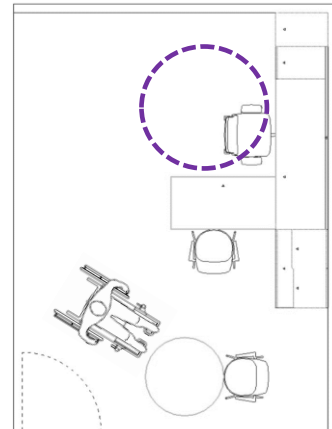

EXECUTIVE OFFICES



# EXECUTIVE OFFICE

Typical Module - 12'-0" X 16'-0"

Columbia Upscale

Cost: \$\$ [10,521.11 total sell]

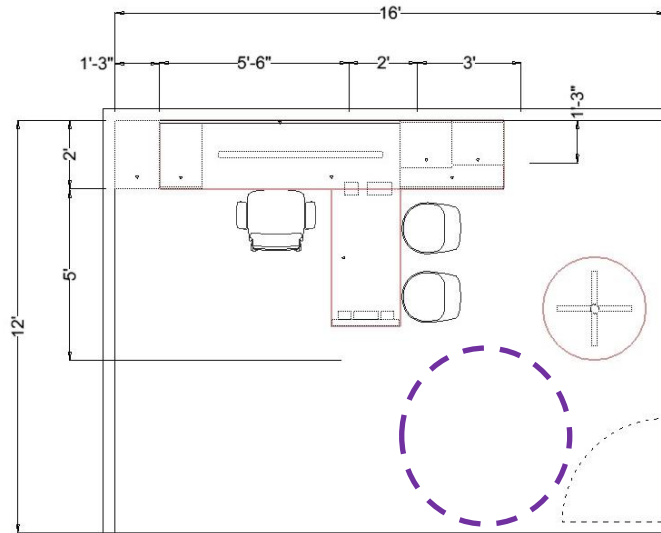

View 1

Dimensions

View 2



# EXECUTIVE OFFICE

Typical Module - 12'-0" X 16'-0"

Columbia Ergonomic

Cost: \$\$\$ [11,803.51 total sell]

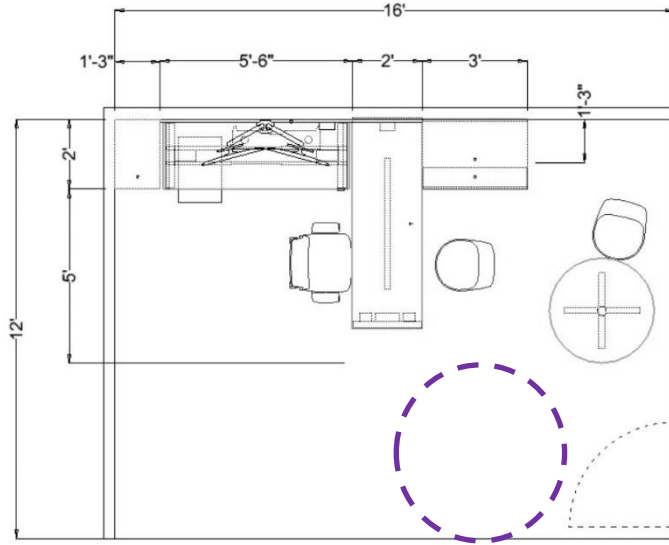

View 1

Dimensions

View 2









# EXECUTIVE OFFICE

Typical Modules - 12'-0" X 16'-0"  
Columbia Oak



# EXECUTIVE OFFICE

Typical Modules - 12'-0" X 16'-0"  
Columbia Acacia



# EXECUTIVE OFFICE

Typical Modules - 12'-0" X 16'-0"  
Columbia Walnut









# FINISHES

## Application Guide



<u>Furniture Component</u>	<u>Palette</u>	<u>Palette Alt</u>
Worksurface	A	C
Return worksurface	A	A
Worksurface support/ Leg	D	D
Storage	A	A
Boundary Screen	B	B
Interior Boundary Screen	C	C
Panel Fabric (above worksurface)	E	E
Panel Fabric (below worksurface)	E	F
Panel Trim	D	D
Personal Shelf	G	G

# ACACIA

## Scheme A

### Worksurfaces & Chairs

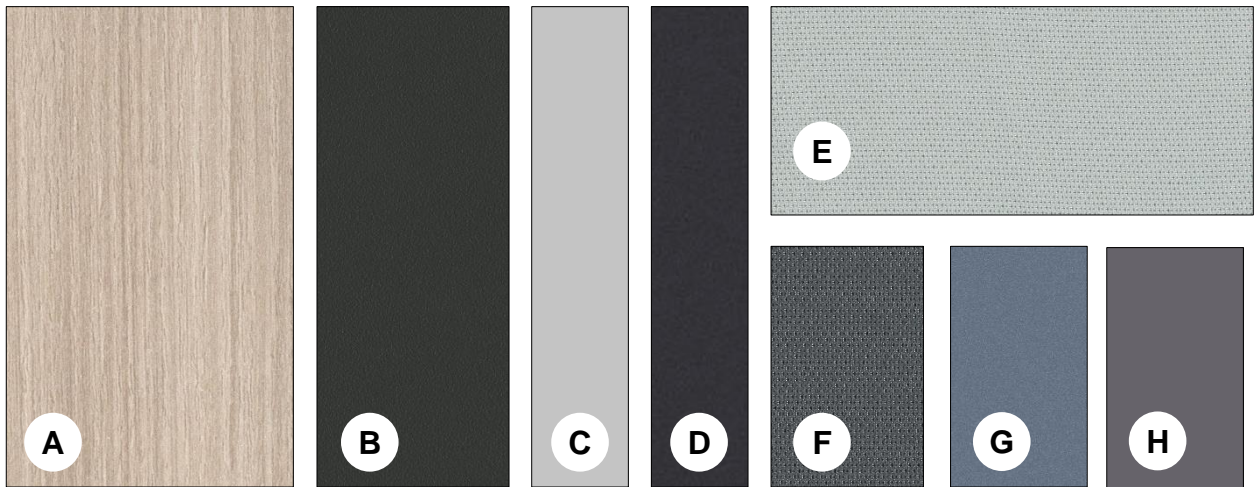

#### Worksurfaces Identification Key

- A Primary Laminate - Acacia
- B Secondary Laminate - Merle
- C Tertiary Laminate - Seagull
- D Painted Trim - Midnight
- E Primary Panel Fabric - Alloy, Silver
- F Secondary Panel Fabric - Alloy, Currency (if selected)
- G Accent Metallic Paint - Smoked Mica
- H Accent Glass - Merle

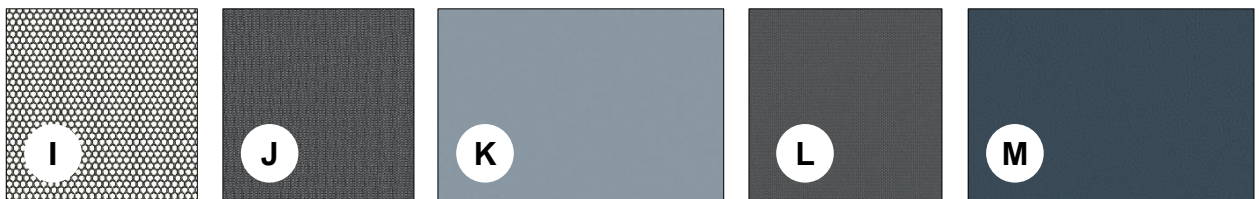

#### Chairs Identification Key

- I Task Chair Back - 3D Knit Graphite
- J Task Chair Seat - Cogent Connect Graphite
- K Guest Chair Shell - Ice
- L Guest Chair Seat - Cogent Connect Graphite
- M Alternate Task Chair Fabric - Brisa Cambridge Blue

ACACIA  
Scheme A  
Architectural Finishes

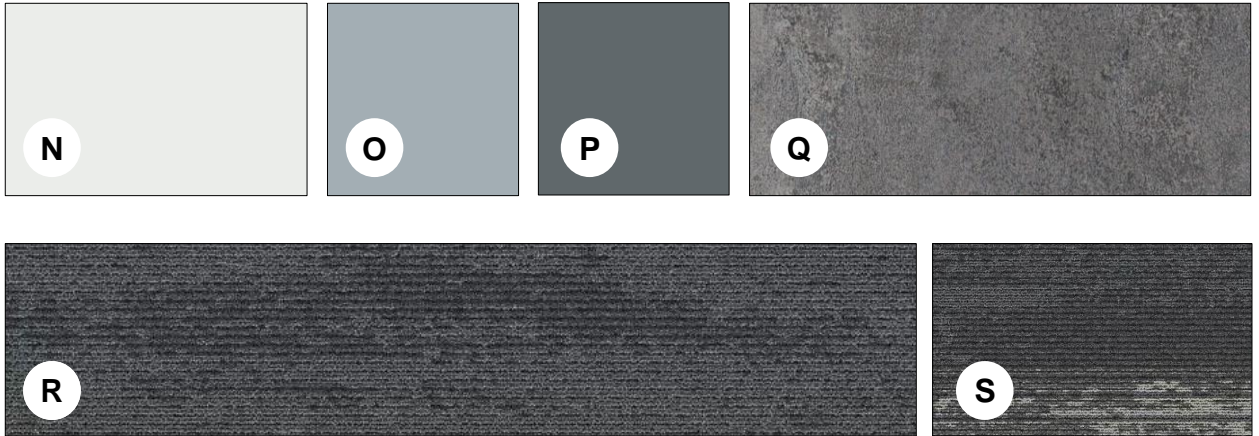

Finishes Identification Key

- N Wall Paint Eggshell- Benjamin Moore Decorator's White CC-20
- O Accent Paint Eggshell - Benjamin Moore Solitude AF-545
- P Wall Base - Johnsonite 71 Storm Cloud CG
- Q LVT - Mannington Tempus Pause
- R Carpet - Mohawk Shared Path 959 Slate (80%)
- S Carpet - Mohawk Metallic Path 949 Slate Burst (20%), brick Ashlar

# OAK

## Scheme B

### Worksurfaces & Chairs

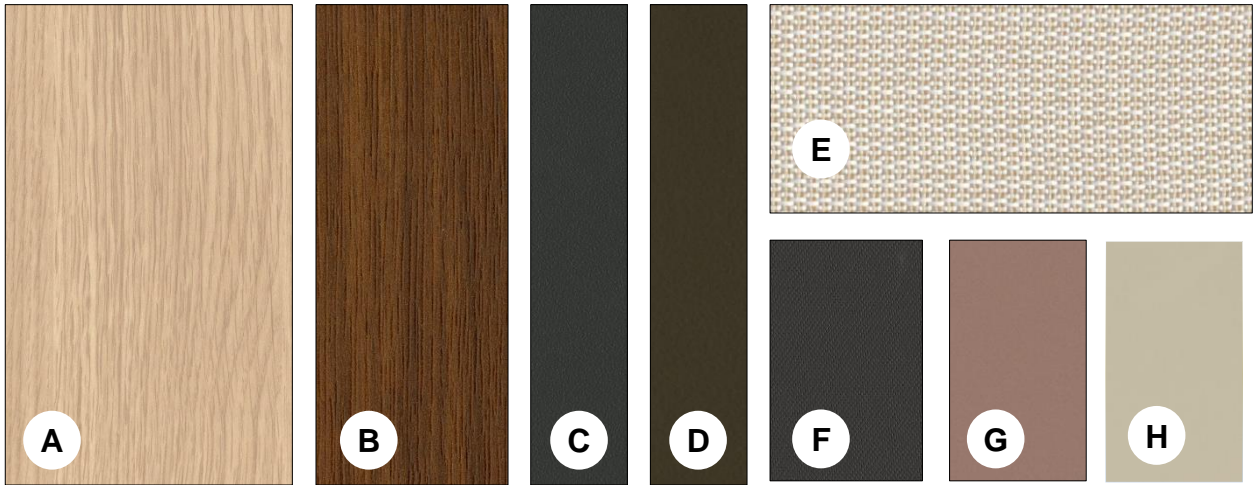

#### Worksurfaces Identification Key

- A Primary Laminate - Clear Oak
- B Secondary Laminate - Walnut Heights
- C Tertiary Laminate - Merle
- D Painted Trim - Dark Bronze
- E Primary Panel Fabric - Charm, Mimosa
- F Secondary Panel Fabric - Alloy, Iron
- G Accent Metallic Paint - Matte Copper
- H Accent Glass - Bronze Mirror



#### Chairs Identification Key

- I Task Chair Back - 3D Knit Root Beer
- J Task Chair Seat - Cogent Connect Root Beer
- K Guest Chair Shell - Saffron
- L Guest Chair Seat - Cogent Connect Root Beer
- M Alternate Task Chair Fabric - Brisa Bridle

# OAK Scheme B

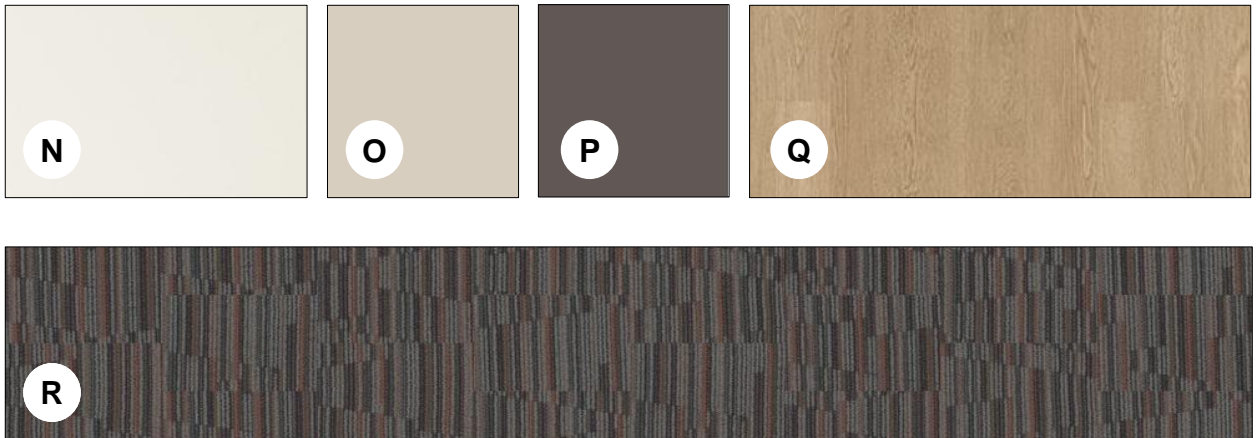

## Finishes Identification Key

- N Wall Paint Eggshell- Benjamin Moore Glacier White OC-37
- O Accent Paint Eggshell - Benjamin Moore Cedar Key oC-16
- P Wall Base - Johnsonite TB1 Peppercorn
- Q LVT - Interface, Northern Grain, A02611 Oak Satin
- R Carpet - Shaw Alongside Tile, Join Color 50865



# WALNUT

## Scheme C

### Worksurfaces & Chairs

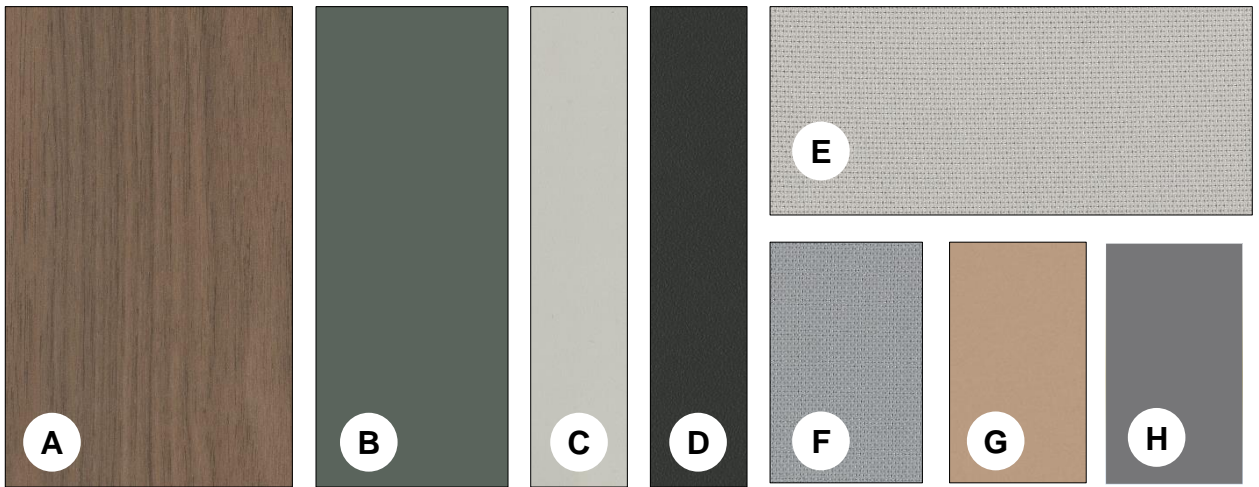

#### Worksurfaces Identification Key

- A Primary Laminate - Virginia Walnut
- B Secondary Laminate - Dark Olivine
- C Tertiary Laminate - Dune
- D Painted Trim - Merle
- E Primary Panel Fabric - Charm, Bubbly
- F Secondary Panel Fabric - Alloy, Element
- G Accent Metallic Paint - Matte Brass
- H Accent Glass - Greyscale



#### Chairs Identification Key

- I Task Chair Back - 3D Knit Jungle
- J Task Chair Seat - Cogent Connect Jungle
- K Guest Chair Shell - Sand
- L Guest Chair Seat - Cogent Connect Jungle
- M Alternate Task Chair Fabric - Brisa Iron



# WALNUT Scheme C

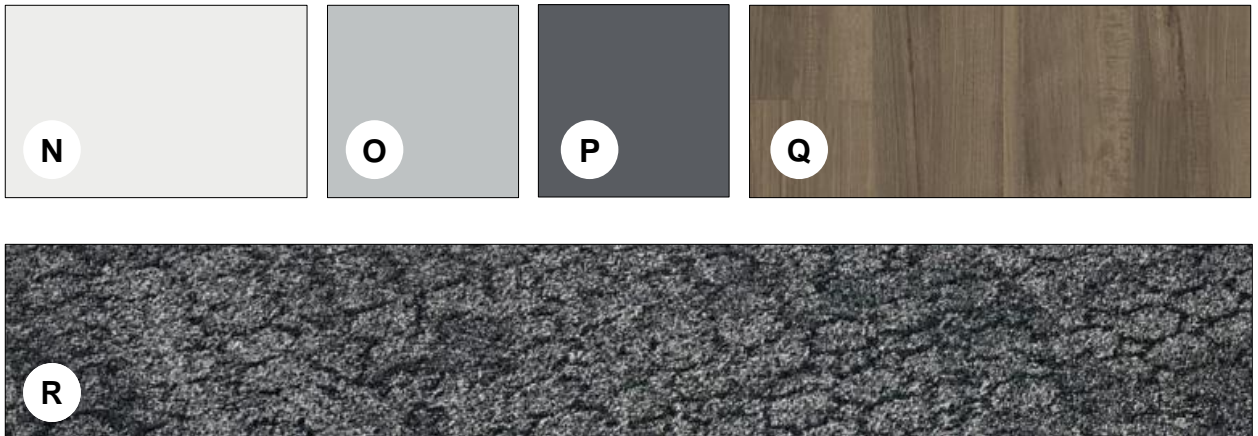

## Finishes Identification Key

- N Wall Paint Eggshell- Benjamin Moore White OC-151
- O Accent Paint Eggshell - Benjamin Moore Eternity AF-695
- P Wall Base - Johnsonite TA6 Bedrock
- Q LVT - Interface, Northern Grain, A02607 Dark Wash
- R Carpet - Mercer Street in Graphite Circle 105767, brick